



WLA LED Series

SPECIFICATIONS

- Die Formed Aluminum Housing
- Tempered Clear Flat Glass Lens
- Bronze, Black or White Powder Coat Finish, Optional Custom Color
- CRI LED Aluminum Substrate Board
- Universal Volt LED Driver 120-277V, Optional 480V
- 4K or 5K LED Color Options
- Surge Protection Built into Electronic Driver
- Super Saver or High Output Driver Optional
- Optional Twist-Lock Photocell
- Optional House Side Shield
- Optional Dimming

APPLICATIONS

- General Area Lighting
- Industrial Parks, Public Transportation, Airports
- Office Buildings, Medical Facilities, Communities

ELECTRICAL

- 120-277V; 50/60Hz
- Optional 480V; 50/60Hz
- 435 Watts; 50,700 Lumens
- 542 Watts; 59,200 Lumens

INSTALLATION

- Mounts with a Wall Bracket, Round Pole, Square Pole, Arm Mount or Slip Fitter

CERTIFICATIONS/LISTINGS

- CSA Listed
- IP65
- Listed for Wet Locations



PROJECT _____ TYPE _____

QTY _____ NOTES _____ APPROVAL _____

ORDERING/SPECIFYING INFORMATION:

EXAMPLE: WLA L 435 T3 SS 40K UNV

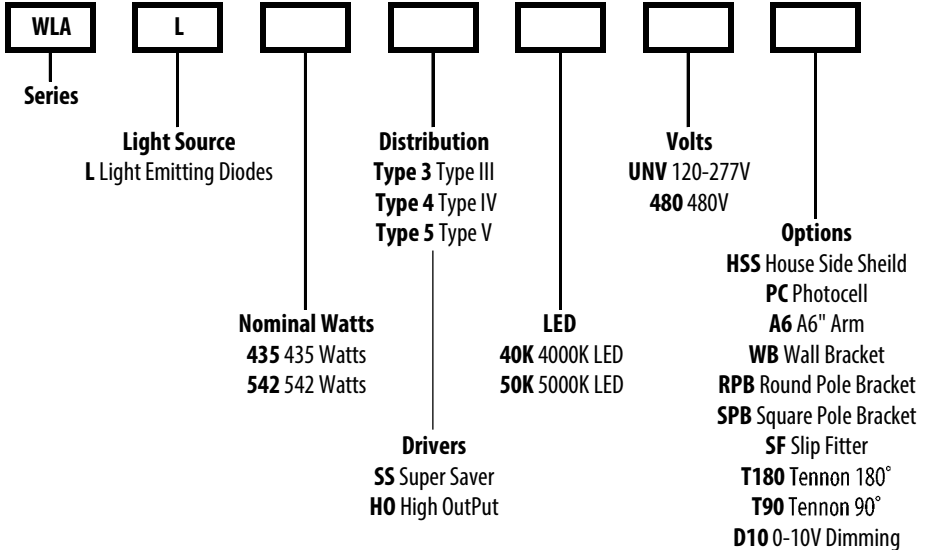

SPECIFICATIONS

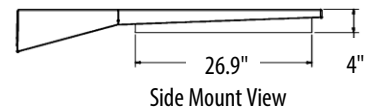
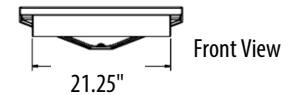
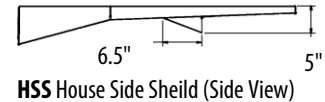
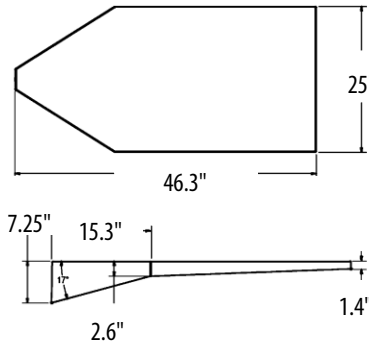

OPTIONS/ACCESSORIES

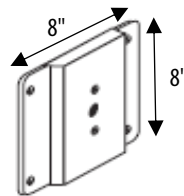

WB Wall Bracket



RPB Round Pole Bracket
4" or 5" Pole

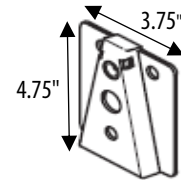
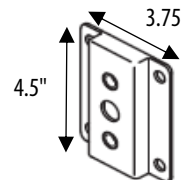

SPB Square Pole Bracket

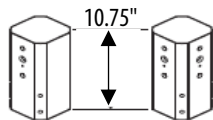

T180 Tenon 180° T90 Tenon 90°

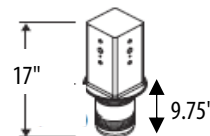

SF Slip Fitter (4" or 5" Poles)

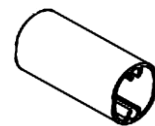

A6 A6" Arm

Specifications Subject to Change

